

**PREFEITURA MUNICIPAL DE SARANDI**

Palácio Municipal Dr. Mário Azambuja  
PRAÇA GETULIO VARGAS S/N-SARANDI-RS

Projeto:	<b>EMEI BEM TE VI</b>	data:	JAN/2016
Proprietário:	PREFEITURA MUNICIPAL DE SARANDI Paulo Rodolfo Vicari Kasper - Prefeito Municipal	área:	-
Responsável Técnico:	RENATA CRISTINA CASTOLDI Arquiteta e Licenciada CAUIRS A70045-2	esc:	INDICADA
Projeto:	<b>COZINHA REFEITÓRIO E LAVANDERIA</b>	pranchas:	<b>02</b>

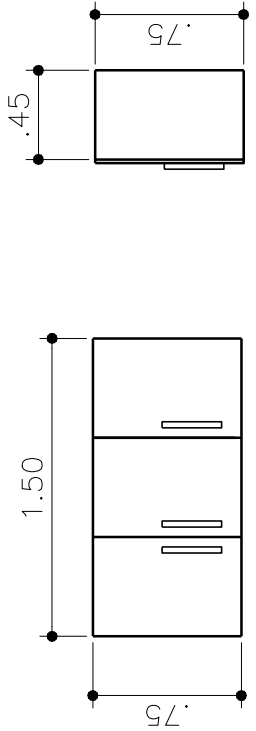
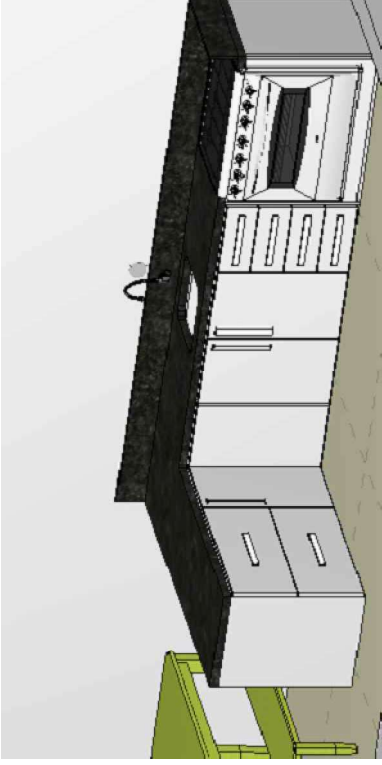
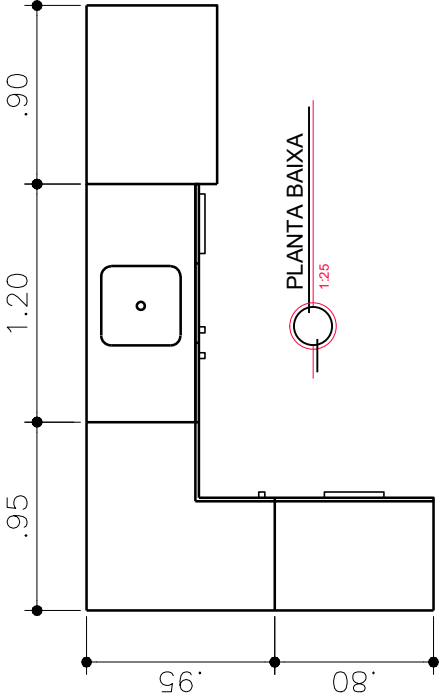

**VISTA FRONTAL**  
1:25

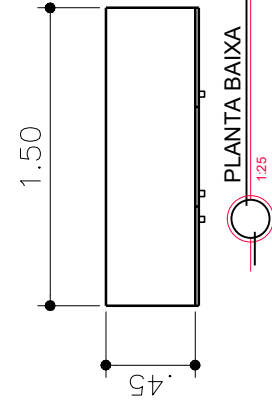

**VISTA LATERAL**  
1:25

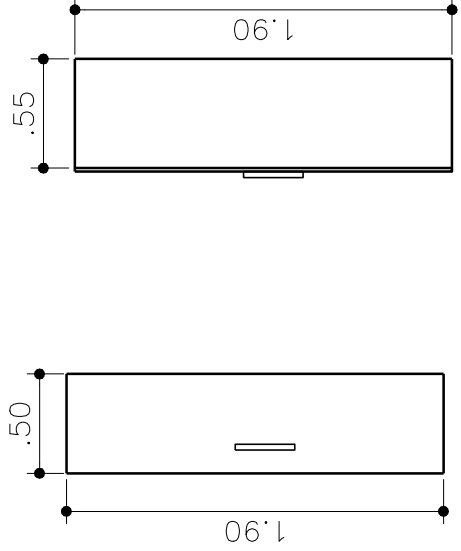
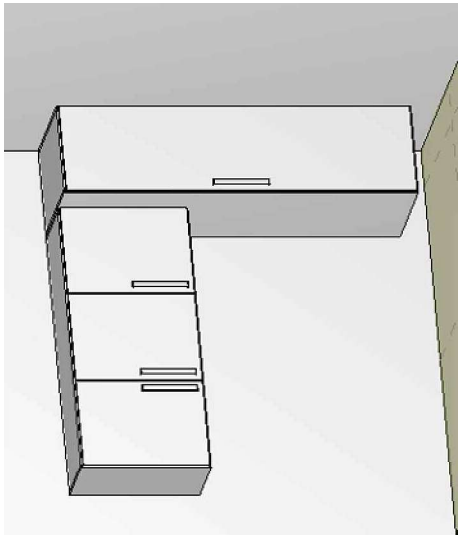

**VISTA FRONTAL**  
1:25

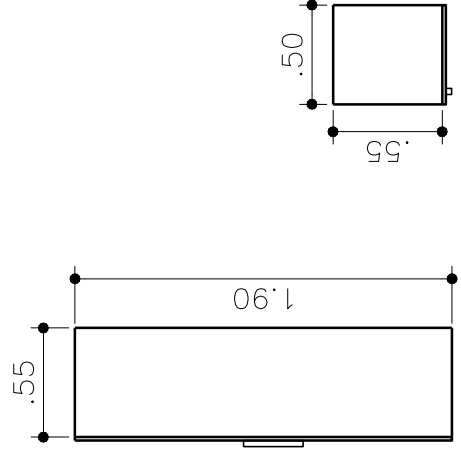

**VISTA LATERAL**  
1:25

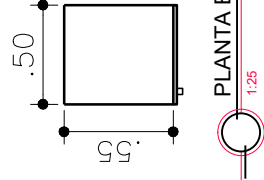

**PLANTA BAIXA**  
1:25